

Emma 50S

!Heat-High Voltage-Peak-Protected
Does Not Produce Frequency Interference

Marine Grade Downlight

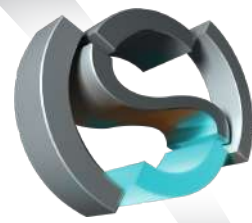

STEIN
MARINE LIVING

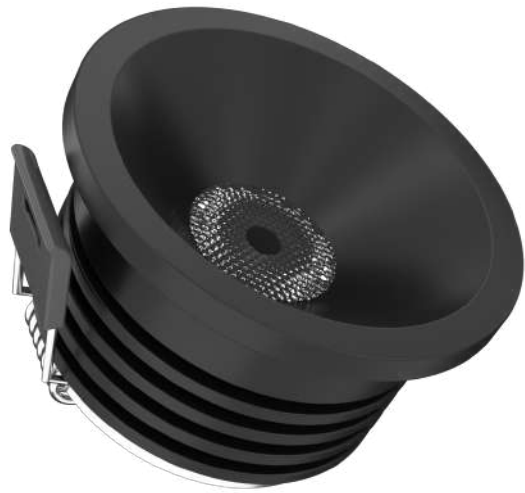

Optional

Special Arrangements Can Be Made For Projects Including Different Sizes, Materials, Material Colors



Optional

Main Light And Emergency
OR
Second Color

Product Specifications

- Power Consumption.....: 3 Watt
- Standart Voltage Internal Driver.....: 24 VDC Protected 60 VDC
- Energy Productivity.....: %95
- Light Source Led.....: Mid Power OR High Power
- Dimmable.....: PWM, Voltage, Current
- Luminous Flux.....: 420 Lumens

Temp Control



Does Not Cause fire



Voltage Limit



Dimensions

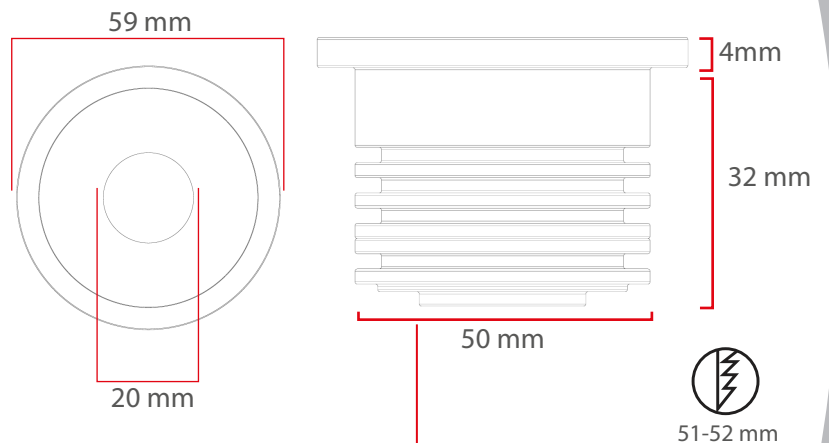

Light Angle

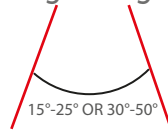

The Driver Is Protected In An Aluminum Housing

Area Of Application
Interior

Material Colors



And Other Ral Codes

Optional Connection

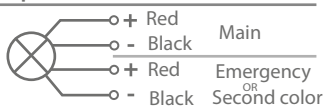

Standart Connection

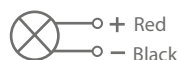

Finishes



Light Colors

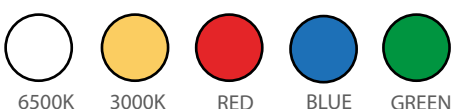

Certifications

