

# Nelly 90-20



**!Heat-High Voltage-Peak-Protected  
Does Not Produce Frequency Interference**

Marine Grade Downlight

Optional

Special Arrangements Can Be Made For Projects Including Different Sizes, Materials, Material Colors

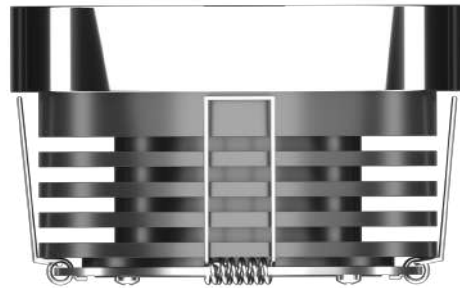

Optional

Main Light And Emergency OR Second Color

## Product Specifications

- Power Consumption.....: 5,7,9,12 Watt
- Standart Voltage Internal Driver.....: 24 VDC Protected 60 VDC
- Optional Driverless.....: Current 3 OR 18 V 300 -1.500 ma
- Light Source Led.....: Mid Power OR High Power
- Dimmable.....: PWM, Voltage, Current
- Luminous Flux.....: 500 - 1.000 - 1.350 Lumens

Temp Control	Does Not Cause fire	Voltage Limit	Does Not Cause Frequency

## Dimensions

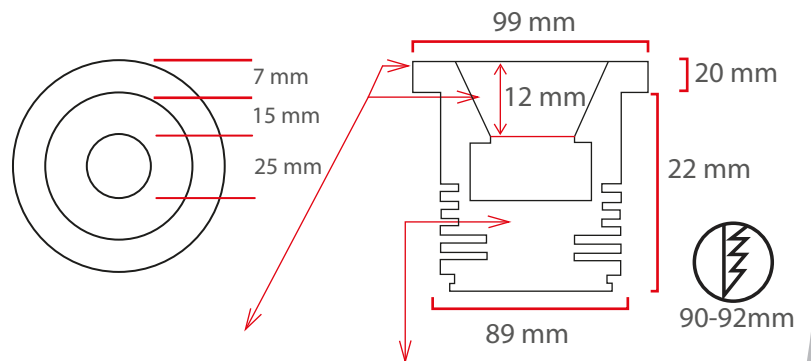

These Dimensions Can Be Changed Optionally

The Driver Is Protected In An Aluminum Housing

## Material Colors



Light Angle



And Other Ral Codes

## Area Of Application

IP 40 Interior

IP 65 Exterior

## Optional Connection

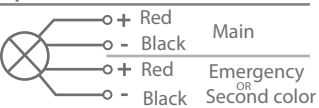

## Standart Connection

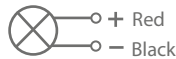

## Light Colors

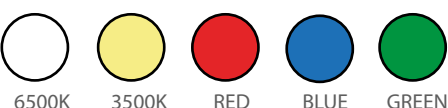

## Certifications

