

Nelly 80-20



**!Heat-High Voltage-Peak-Protected
Does Not Produce Frequency Interference**

Marine Grade Downlight

Optional

Special Arrangements Can Be Made For Projects Including Different Sizes, Materials, Material Colors

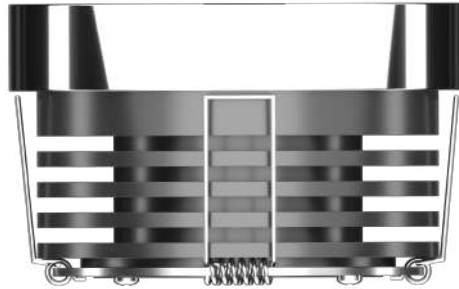

Optional

Main Light And Emergency OR Second Color

Product Specifications

- Power Consumption.....: 5,7,9,12 Watt
- Standart Voltage Internal Driver.....: 24 VDC Protected 60 VDC
- Optional Driverless.....: Current 3 OR 18V 300 -1.500 ma
- Light Source Led.....: Mid Power OR High Power
- Dimmable.....: PWM, Voltage, Current
- Luminous Flux.....: 500 - 1.000 - 1.350 Lumens

Temp Control	Does Not Cause fire	Voltage Limit	Does Not Cause Frequency

Dimensions

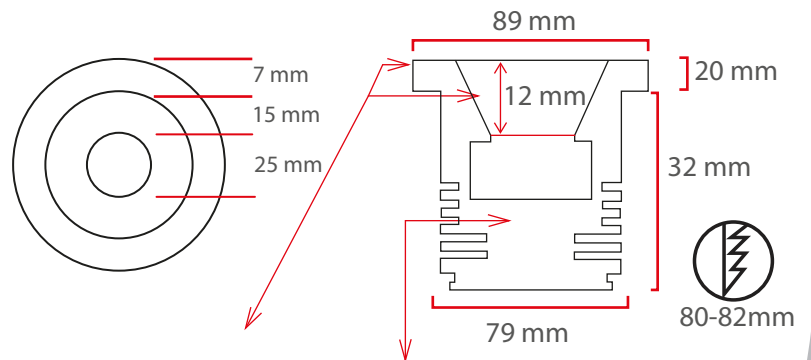

These Dimensions Can Be Changed Optionally

The Driver Is Protected In An Aluminum Housing

Material Colors



Light Angle



And Other Ral Codes

Area Of Application

IP 40 Interior

IP 65 Exterior

Optional Connection

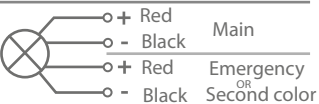

Standart Connection

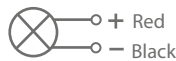

Light Colors

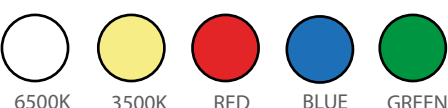

Certifications

