

MEENA S-F

**!Heat-High Voltage-Peak-Protected
Does Not Produce Frequency Interference**

Marine Grade Downlight



Optional

Special Arrangements Can Be Made For Projects Including Different Sizes, Materials, Material Colors

Optional

Main Light And Emergency OR Second Color

Product Specifications

- Power Consumption.....: 5 Watt
- Standart Voltage Internal Driver.....: 24 VDC Protected 60 VDC
- Optional Driverless.....: Current 3 OR 18 V 300 -1.500 ma
- Light Source Led.....: Mid Power OR High Power
- Dimmable.....: PWM, Voltage, Current
- Luminous Flux.....: 700 Lumens

Temp Control



Does Not Cause fire



Voltage Limit



Dimensions

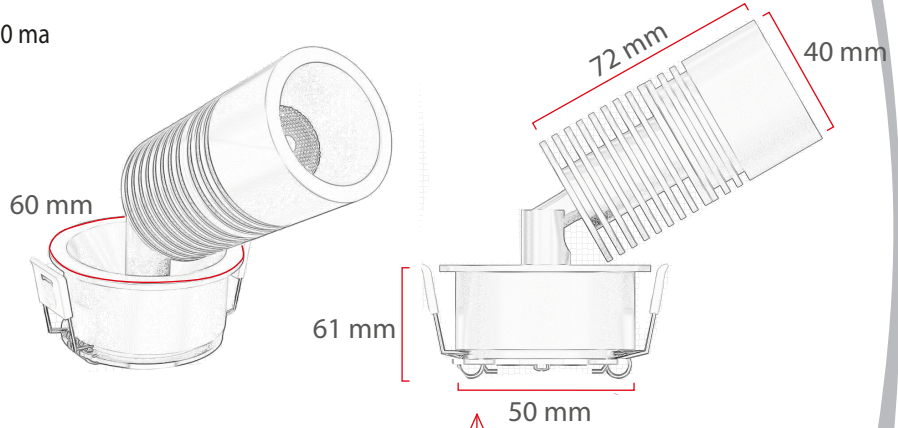

Material Colors



Light Angle

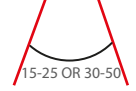

And Other Ral Codes

The Driver Is Protected In An Aluminum Housing

Optional Connection

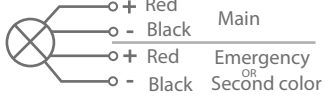

Standart Connection

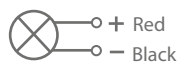

Area Of Application

IP 40 Interior

Light Colors

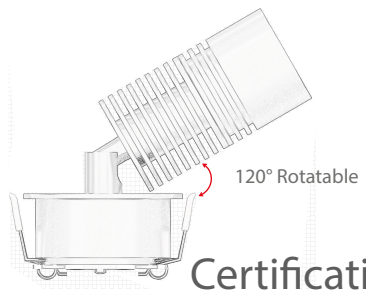
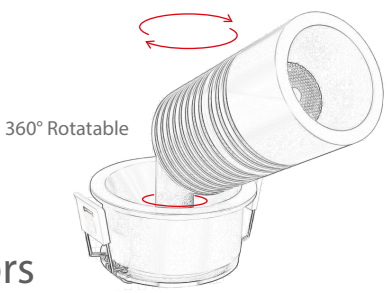
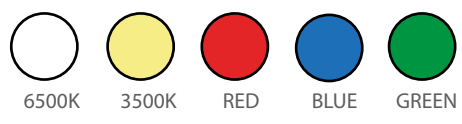

Certifications

