

NELLY X2-H25



**!Heat-High Voltage-Peak-Protected
Does Not Produce Frequency Interference**

Marine Grade Downlight



Optional

Special Arrangements Can Be Made For Projects Including Different Sizes, Materials, Material Colors

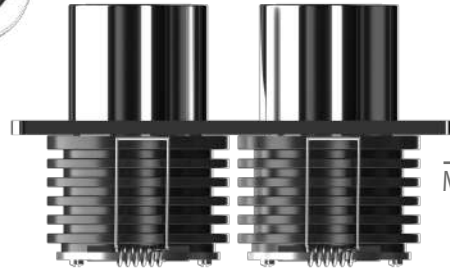

Optional

Main Light And Emergency OR Second Color

Product Specifications

- Power Consumption.....: 3 x 4 Watt = 12 Watt (PER LAMP)
- Standart Voltage Internal Driver.....: 24 VDC Protected 60 VDC
- Optional Driverless.....: Current 3 OR 18 V 300 -1.500 ma
- Light Source Led.....: Mid Power OR High Power
- Dimmable.....: PWM, Voltage, Current
- Luminous Flux.....: 500 - 1.000 - 1.350 Lumens

Temp Control



Does Not Cause fire



Voltage Limit



Dimensions

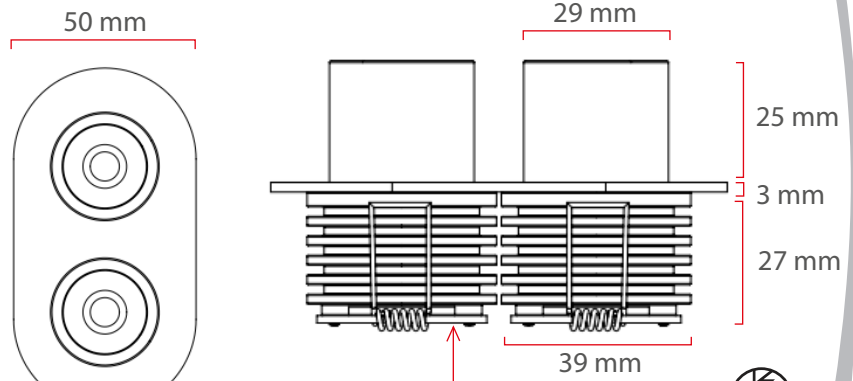

The length of the frame part of the product can vary between 25mm, 50mm, or 75mm as desired

The Driver Is Protected In An Aluminum Housing



40-42 mm

Material Colors

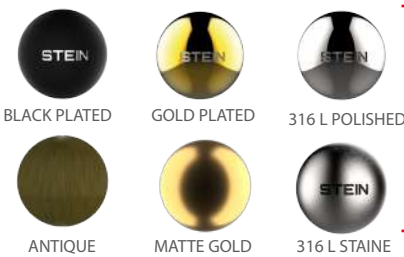

Light Angle

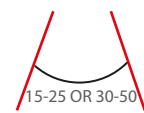

And Other Ral Codes

Optional Connection

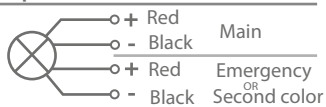

Standart Connection

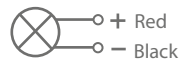

Area Of Application

IP 40 Interior Optional IP65



Light Colors

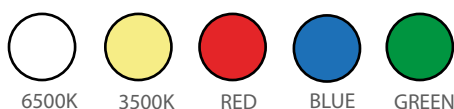

Certifications

