

Nelly V2-28-34-75



**!Heat-High Voltage-Peak-Protected
Does Not Produce Frequency Interference**

Marine Grade Downlight



Optional

Special Arrangements Can Be Made For Projects Including Different Sizes, Materials, Material Colors



Optional
Main Light And Emergency
OR
Second Color

Product Specifications

- Power Consumption.....: 5,7,9,12Watt
- Standart Voltage Internal Driver.....: 24 VDC Protected 60 VDC
- Optional Driverless.....: Current 3 OR 18 V 300 -1.500 ma
- Light Source Led.....: Mid Power OR High Power
- Dimmable.....: PWM, Voltage, Current
- Luminous Flux.....: 500 - 1.000 - 1.350 Lumens

Temp Control  Does Not Cause fire  Voltage Limit 

Dimensions

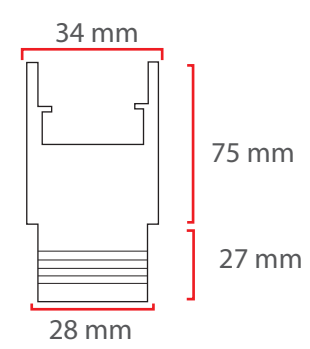
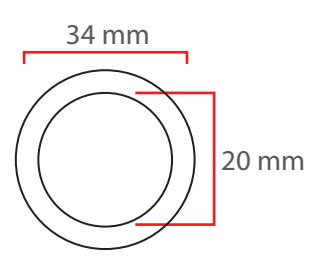

Material Colors



Light Angle

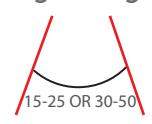

And Other Ral Codes

These Dimensions Can Be Changed Optionally

The Driver Is Protected In An Aluminum Housing

Optional Connection



Standart Connection

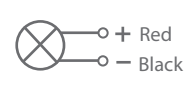

This product is designed to fit into any space with these dimensions and you can easily mount it by drilling as many holes as you like



Light Colors

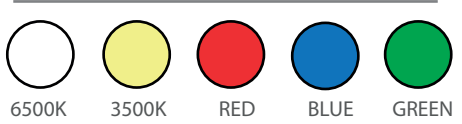

Certifications

