

MILA 40 A



**!Heat-High Voltage-Peak-Protected
Does Not Produce Frequency Interference**

Marine Grade Downlight

Optional

Special Arrangements Can Be Made For Projects Including Different Sizes, Materials, Material Colors

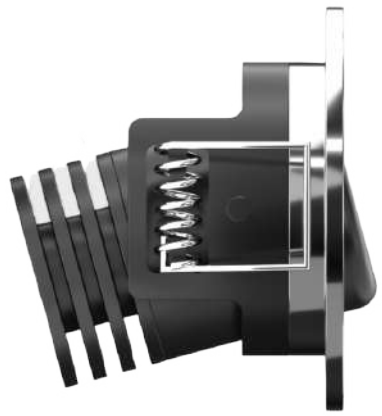

Optional

Main Light And Emergency OR Second Color

Product Specifications

- Power Consumption.....: 5,7,9,12Watt
- Standart Voltage Internal Driver.....: 24 VDC Protected 60 VDC
- Optional Driverless.....: Current 3 OR 18V 300 -1.500 ma
- Light Source Led.....: Mid Power OR High Power
- Dimmable.....: PWM, Voltage, Current
- Luminous Flux.....: 500 - 1.000 - 1.350 Lumens

Temp Control Does Not Cause fire Voltage Limit Does Not Cause Frequency

Dimensions

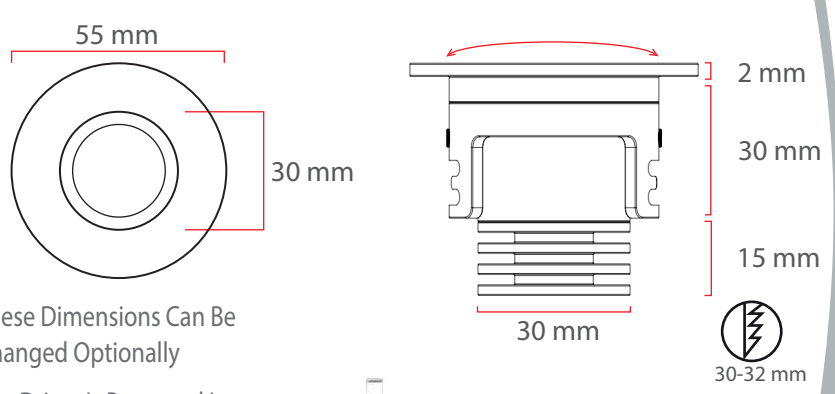

Material Colors



Light Angle

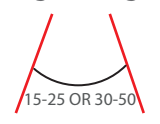

And Other Ral Codes

These Dimensions Can Be Changed Optionally

The Driver Is Protected In An Aluminum Housing

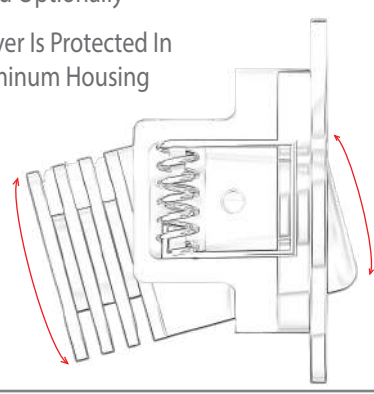

Our product can be easily moved along the horizontal axis. When users position it as desired and release it, the lamp remains fixed in that position. This flexibility perfectly caters to your lighting needs in any environment.

Optional Connection

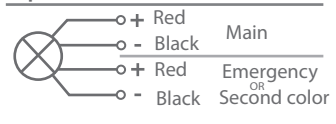

Standart Connection

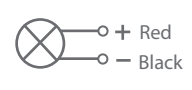

Light Colors

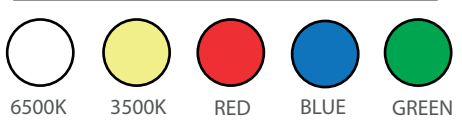

Certifications

