

GLASS 60 V2

!Heat-High Voltage-Peak-Protected
Does Not Produce Frequency Interference

Marine Grade Downlight



Optional

Special Arrangements Can Be Made For Projects Including Different Sizes, Materials, Material Colors

Optional

Main Light And Emergency
OR
Second Color

Product Specifications

- Power Consumption.....: 4 Watt
- Standart Voltage Internal Driver.....: 24 VDC Protected 60 VDC
- Optional Driverless.....:
- Light Source Led.....: Mid Power OR High Power
- Dimmable.....: PWM, Voltage, Current
- Luminous Flux.....: 560 Lumens

Material Colors



Light Angle

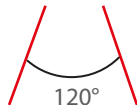

Temp Control Does Not Cause fire Voltage Limit Does Not Cause Frequency

Dimensions

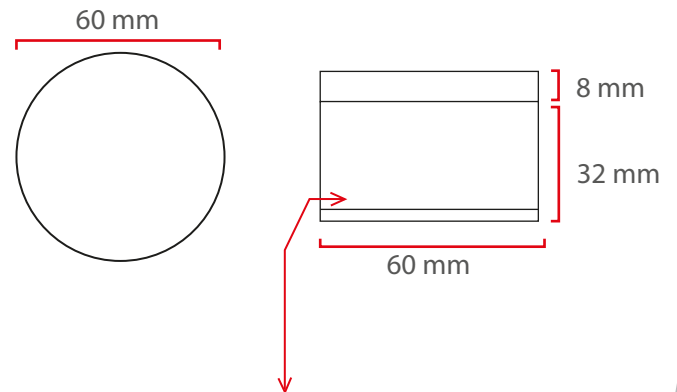

The Driver Is Protected In An Aluminum Housing

Optional Connection

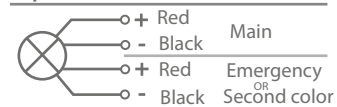

Standart Connection

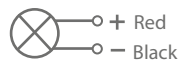

Area Of Application

Exterior IP65 Interior

Mounting

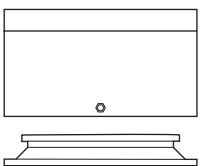

Loosen the set screw in the specified section and remove the lower part

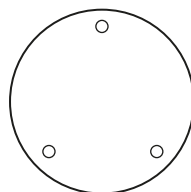

Mount the lower part by screwing it into the desired location

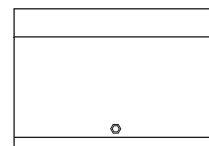

Reassemble the upper part and use it as desired

Light Colors

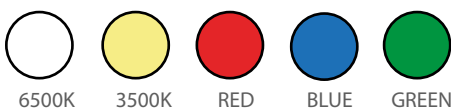

Certifications

