

# Mila 60S-V2 New High Tech Series

**! Heat - High Voltage - Peak- Protected  
Does Not Produce Frequency Interference**

Marine grade downlight



## Optional

Special Arrangements Can Be Made For Projects Including Different Sizes, Materials, Material Colors



## Optional

Main Light And Emergency OR Second Color

## Product Specifications

- Power Consumption : 5,6,9,12, Watt
- Standart Voltage Internal Driver : 24 VDC Protected 60 VDC
- Optional Driverless : Current 18 V 300 -1.500 ma
- Light Source Led : Mid Power OR High Power
- Dimmable : PWM, Voltage, Current
- Luminous Flux : 1.000 -1.350-1.800 Lumens

Temp Control Does Not Cause fire Voltage Limit Does Not Cause Frequency

## Dimensions

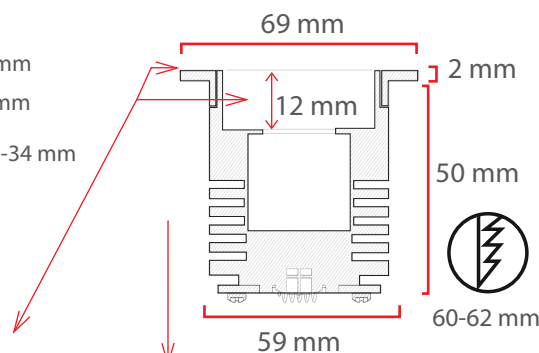
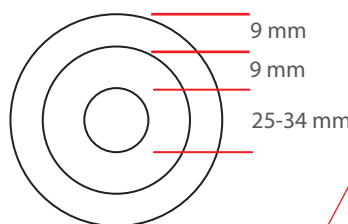

## Material Colors

## Light Angle



And Other Ral Codes

These Dimensions Can Be Changed Optionally

The Driver Is Protected In An Aluminum Housing

## Optional Connection

## Standart Connection

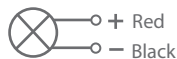
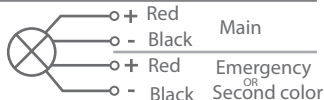

## Area Of Application

IP 40 Interior

IP 65 Exterior

## Interior

## Exterior

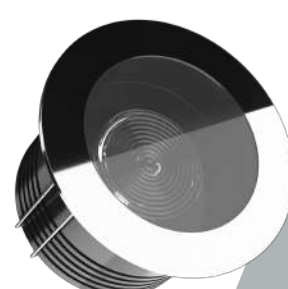
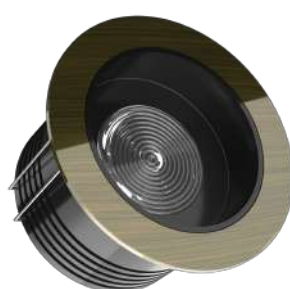

## Light Colors

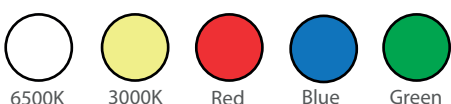

## Certifications

