

GLASS 110

**!Heat-High Voltage-Peak-Protected
Does Not Produce Frequency Interference**



Marine Grade Downlight



Optional

Special Arrangements Can Be Made For Projects Including Different Sizes, Materials, Material Colors

Optional

Main Light And Emergency
OR
Second Color

Product Specifications

- Power Consumption.....: 10 Watt
- Standart Voltage Internal Driver.....: 24 VDC Protected 60 VDC
- Optional Driverless.....:
- Light Source Led.....: Mid Power OR High Power
- Dimmable.....: PWM, Voltage, Current
- Luminous Flux.....: 500 - 1.000 - 1.350 Lumens

Temp Control Does Not Cause fire Voltage Limit Does Not Cause Frequency

Dimensions

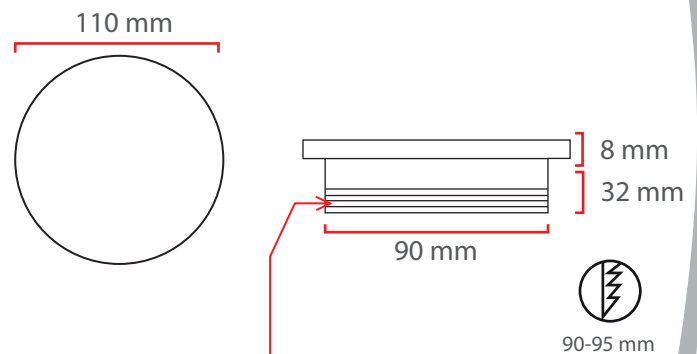

The Driver Is Protected In An Aluminum Housing

Material Colors



Light Angle

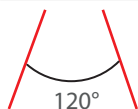

Area Of Application

Exterior IP65 Interior

Optional Connection



Standart Connection



Mounting



You can easily assemble the product by stretching the springs and inserting it into the hole you've pierced

Light Colors

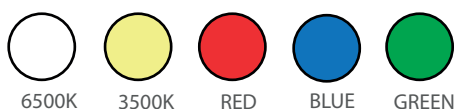

Certifications

